

Hatsuyuki **ICE SHAVER**

MODEL HF-500E

Instruction Manual



Manufactured by :

CHUBU CORPORATION

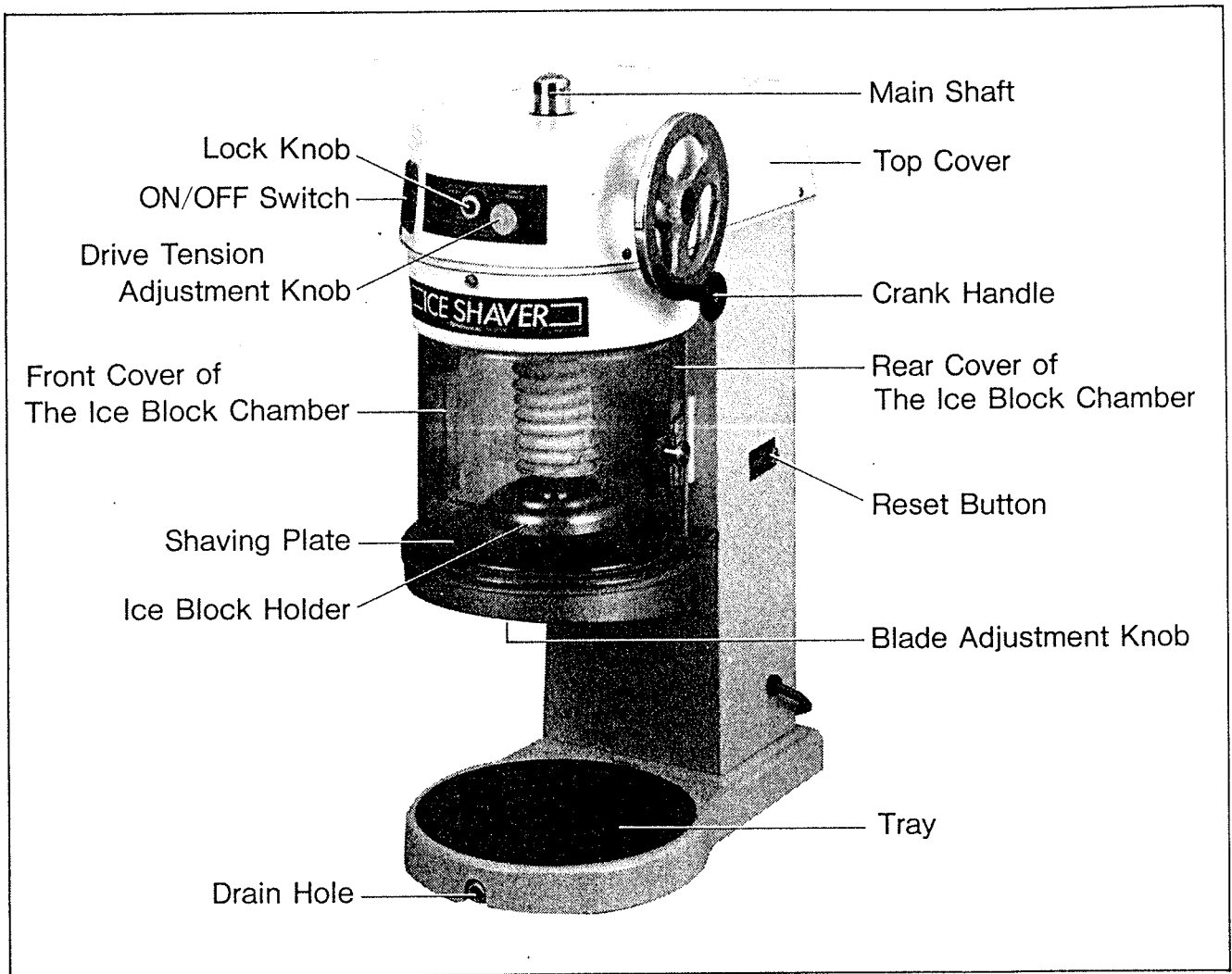

Please be sure to observe the followings to avoid electrical shock:

- Install machine on a sturdy, level, and waterproof surface.
 - Be sure to use a grounded, three-prong, 115V electrical outlet.
 - Keep water away from electrical portions of machine.
-

Attention

- When machine is not to be used for many hours, store it in a moisture-free area after it has been completely dried.

** Do not operate the machine outside

Operating the machine outside or in the rain will cause electric bleeding or electric shock.

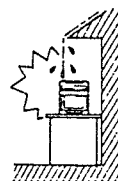

** Do not install the machine in a damp or wet place

It can cause electric bleeding or electric shock.

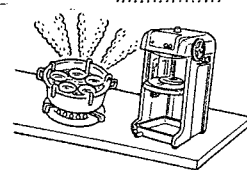

** Do not install/place the machine close to any heating appliance

Never install/place the machine close to any heating appliance such as a gas burner. It can cause melting and/or burning of plastic cover.

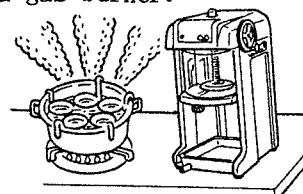

** This machine is for "COMMERCIAL USE"

Be sure to keep the machine away from children to avoid electric shock or injury.



** Do not pour water over the machine or immerse machine in water

It can cause a short circuit or electric shock, as well as rust and other water-related problems.

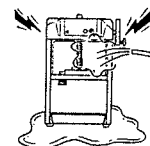

** Do not damage power supply cord

Never work on power cord and never pull, twist or bundle it. Do not place a heavy things on it. It can damage the power cord and can cause electric shock or fire.

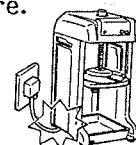

** Keep plug clean and plug into outlet correctly

Always keep plug clean and plug into outlet correctly. Dirty plugs or imperfectly connected plugs can cause electric shock or fire.



Attention to Dust

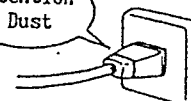

** Do not touch any electrical parts (such as plug or switch) with wet hands

It can cause electric shock.

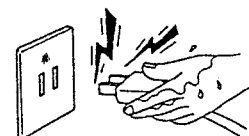

WARNING

- ** In the event of circuit breaker moving to "OFF" position, please contact the machine vendor. Switching breaker to "ON" position incorrectly or by force can cause electric shock or fire.

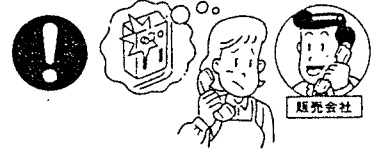

- ** Should accidents or irregular operation occur, TURN OFF the main switch and unplug from outlet. Immediately contact your machine vendor for a correct repairs. Continued operation of a faulty machine can/will cause electric shock or fire.



- ** For cleaning inside the ice hopper or changing blades, be sure to TURN OFF the main switch and always put on gloves while cleaning/changing blade works. Never touch blades directly. They are very sharp and can cause injury.



- ** Never try to disassemble or repair the machine by yourself. Always call a qualified technician. Incorrect repair will likely cause irregular operation or electric shock, fire or injury.

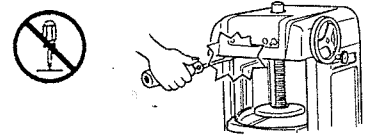

- ** Do not attempt to alter the machine in any way. It can cause electric shock or fire.

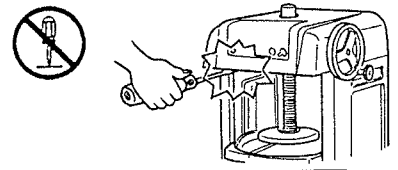

CAUTION

- ** Always install the machine on a stable and flat surface. Irregular or imperfect installation can cause the unit to tip or fall and is therefore dangerous.

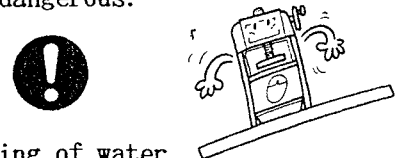

- ** Install the machine in a location unaffected by occasional dripping of water. Melting ice will drip and can, therefore, drip onto things surrounding the machine.

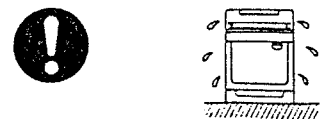

- ** Keep the machine away from direct sunlight. It can cause a damage to plastic parts.



- ** Do not introduce foreign substances into the unit such as spoons, buttons, toothpicks, etc. It may cause undue load on the motor, resulting in excessive motor heating or fire.



- ** Should the motor stop under operation, be sure to switch OFF and unplug the unit. Remove any obstacles (foreign substances such as spoons, buttons, toothpicks, etc.)



- ** When cleaning, be sure to switch OFF and unplug the unit before doing so. Cleaning with the power or switch on is very dangerous and can cause electric shock or injury.



- ** Never use inflammable sprays near the machine and never place volatile or inflammable materials close to the machine. Sparks from the switch could possibly cause fire.

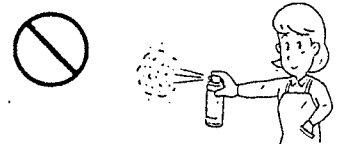

- ** When you unplug the unit, be sure to hold the plug while you pull it out of the outlet. Never pull the power cable. It may damage the plug/cable and can cause electric shock or fire.

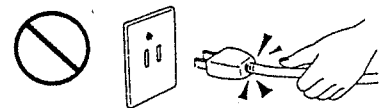

- ** After the day's business is finished, be sure to switch OFF and unplug the unit for safety.

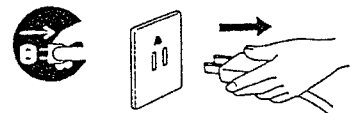

- ** For disposal of a disused unit, please contact local disposal experts or the nearest vendor. Abandoned machines are dangerous. Treat blade on machine as a dangerous item when disposing machine.



- ** When you sell or give the machine to a 3rd party, make sure that this "OPERATION MANUAL" goes with the unit for safety and correct operation.



HOW TO USE

NOTICE: (a) If ice to be sliced has a white and/or opaque (cloudy) appearance, it is over-frozen and should thaw for a while.
Over-frozen ice is not suitable for proper shaving.

(b) Please put ice only in the machine.

1) Plug in machine

Please make sure that power switch is turned to off position before plugging in unit.

2) Preparation and placement of ice

- a) Open front cover by moving to left.
- b) Turn the block ice holder wheel counter-clockwise to raise the drive shaft.
- c) Take your hand from block ice holder wheel to make sure that ice block holder does not descend.
- d) Put block ice on the center of shaving table. Be sure that block ice does not stick over shaving table edges.
- e) Remove hand from ice.
- f) Turn the block ice holder wheel clockwise, so that ice block gripper points engage firmly.
- g) Close sliding front cover by moving to right.
(Be sure to shut the cover firmly.
For safety reasons, the Switch will not engage in the event of imperfectly shutting cover.)

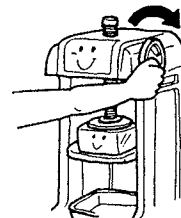

WARNING

When loading/unloading ice, or when cleaning, checking, or changing blades, be sure to turn off the main switch and always wear gloves. Do not touch blade.
(It can cause injury.)

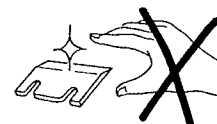

CAUTION

- a) Be sure to set block ice correctly/firmly.
(Incorrect placement of ice can cause dangerous bouncing.)
- b) Do not touch the block ice gripper points.
(Gripper points are extremely sharp. Be careful when loading/unloading ice, cleaning, or changing blades.)

- 3) Receiving shaved ice to a cup
Place cup to receive shaved ice under shaving table.

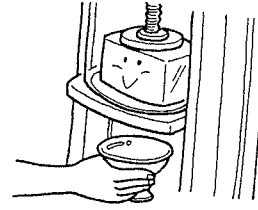

- 4) Switching on the main switch

CAUTION

Do not touch rotating parts such as drive shaft, or block ice holder wheel.
(It is dangerous and can cause to injury.)

- 5) Adjusting texture of shaved ice

- a) Turn blade adjustment knob for desired texture of shaved ice.
(For your information, the usual texture of shaved ice is about 1/32 inch.)
- b) For coarser shaving, turn the blade adjustment knob clockwise, and for finer shaving, turn counter-clockwise.
(Each rotation of the adjusting knob will increase/decrease setting by 1/32 inch. Maximum adjustment is 2-3 rotations.)

- 6) Switching off the main switch

- 7) Unplug the machine

Be sure to unplug machine after use.

SAFETY SWITCH

For safety purposes, the machine is designed to stop automatically during operation, should the front cover be opened.

Note: Do not use the front cover as an on/off-switch.
This can be cause operational problems.

UNLOADING ICE

- 1) Switch off.
- 2) Turn the block ice holder wheel counter-clockwise to raise block ice holder.
- 3) Turn the lock knob clockwise and lock the main shaft.
- 4) Open the front cover.
- 4) Remove block ice from shaving table.
- 5) Turn the lock knob counter-clockwise and unlock the shaft.
- 6) Turn block ice holder wheel clockwise to lower it.
- 7) Turn the lock knob clockwise and lock the shaft for safety.

CAUTION

Please handle block ice remnants carefully, as sometime they have sharp edges!

ADJUSTING DRIVE TENSION ADJUSTMENT KNOB

This knob adjusts the "power" to press and hold the block ice. Turn the knob clockwise and the power will be larger and counter-clockwise the power will be smaller.

Adjustment is correct when light proper resistance is felt when raising or lowering crank. If the power to press hold the ice is not enough, this will cause the ice not to shave well or to jump out of the chamber.

If the power is too strong, it will cause the drive gear to be worn out or the ice to crack.

OVERLOAD PROTECTOR RESET

This machine is equipped with an overload protector, which will automatically protect the motor by stopping operation in the event of overload. When protector engages, machine will stop and red button will pop out, please take the following measures:

- a) Switch machine off.
- b) Unplug machine.
- c) Check machine and rectify problem.
(many times it is due to compacted ice on blade.)
- d) Push red button to re-set motor.

HOW TO CHANGE BLADES

WARNING

When loading/unloading ice, cleaning, checking, Changing Blades, be sure to first turn off the power switch and always wear gloves. Do not touch blades. (It can cause injury.)

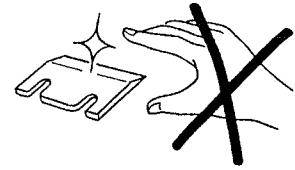

1) Removing Blades

- a) Turn block ice holder wheel counter-clockwise to raise the drive shaft.
- b) Turn the lock knob clockwise and lock the main shaft.
- c) Loosen (2) set screws.
- d) Remove blade from shaving table.

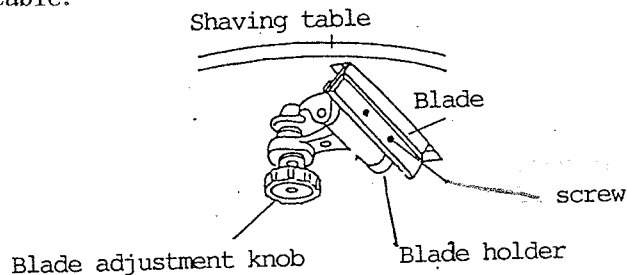

2) Installing Blades

- a) Turn left blade adjustment knob completely, then turn back one half turn.
- b) Insert new blade from the top of the shaving table.
- c) Set the blade edge so that cutting edge is parallel to the plane of the shaving table.
- f) Fix blade in place, using 2 set screws.

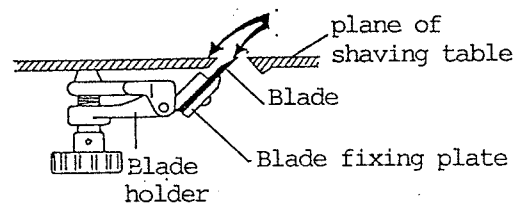
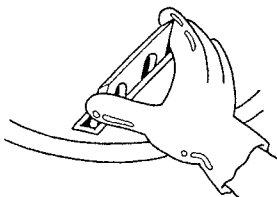

CLEANING & MAINTENANCE

CAUTION

Before cleaning/maintenance, be sure to switch machine off and unplug.

a) Cleaning of exterior

Wipe with a clean, soft, dry-cloth. For heavy dirt accumulations, wipe with a wet cloth dipped in warm water diluted with dish detergent. Remove detergent residue with a soft cloth after cleaning. Do not clean with harsh detergents, solvents or abrasive cleaners. (For details, see Page 8 - 9)

b) Lubrication

Use gear oil (included).
(Mineral oil may also be used.)

a) Drive Shaft Lubrication

Raise drive shaft and lubricate upper threads as necessary.

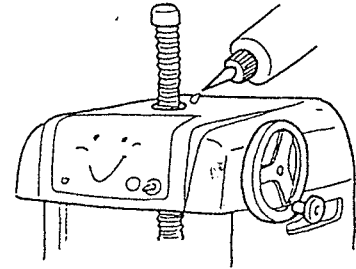

b) Wheel Shaft and Y-shaped Brake Lubrication

Remove top cover, lubricate connected parts via small holes located on top of wheel shaft holder and Y-shaped brake.

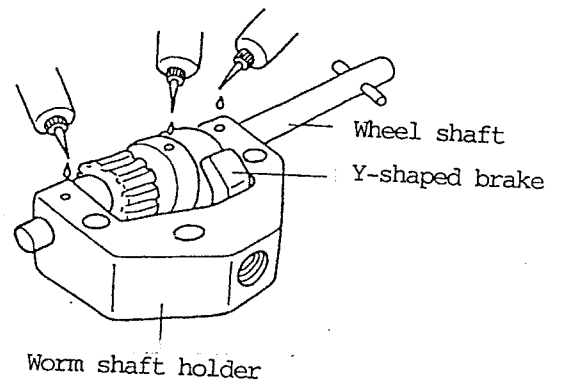

TROUBLE SHOOTING

1. Main shaft fails to turn when motor switch is in the ON position.

- a) No power to the machine - check the power and plug.
- b) Motor drive belt is broken - replace belts.
- c) Front cover is open.

2. Main shaft is turning, but ice is not shaved properly.

- a) Improper blade adjustment - see blade adjustment section.
- b) Dull blade - sharpen or replace blades.
- c) Improper drive tension adjustment (not enough pressure applied to ice).

Increase tension by turning tension adjustment screw clockwise. Tension is properly adjusted when a moderate amount of resistance is felt when raising or lowering the crank. If the power is too strong, it will cause the drive gear to be worn out or the ice to crack.

● Cleaning

Dismantle and clean after daily operation according to the following instruction.

- 1) Disconnect the plug of power supply cord from electric outlet.

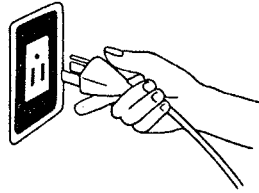

- 2) Open the front cover of the ice block chamber and remove the cover by lifting upward.

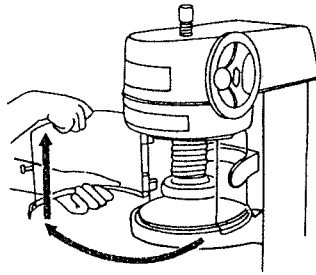

- 3) By rotating crank handle, elevate the ice block holder to the middle position.

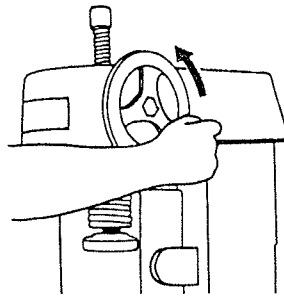

- 4) Turn the Lock knob clockwise and lock the main shaft.

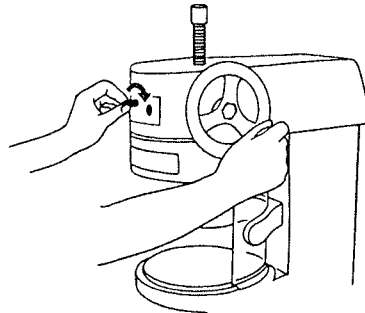

- 5) By holding the upper end of main shaft, turn the ice block holder at the other end of the shaft counter-clockwise and remove it from the main shaft.

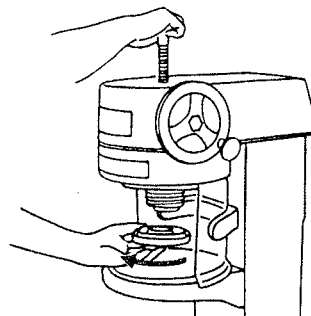

6) Dismantle the ice block holder assembly as follows :

- Take out ice block holder A and B.

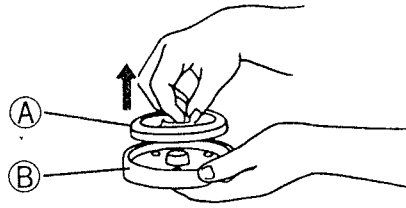

- Pull out (12pcs) ice block holder nails upward.

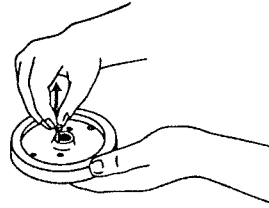

7) Place Lock knob at 'Free' and elevate the main shaft to the upper end position by rotating the crank handle. Then set the Lock knob locked.

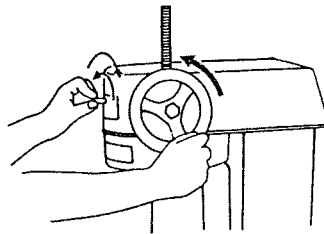

8) Unscrew the fitting screw and remove the rear cover of the ice block chamber by turning it counter-clockwise.

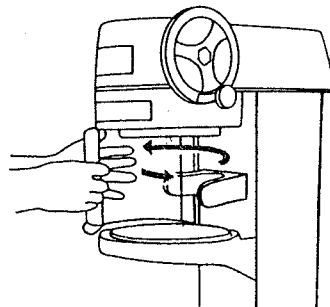

9) Remove wing bolts (2pcs) fastening shaving plate at back of the plate. Raise the shaving plate and remove it.

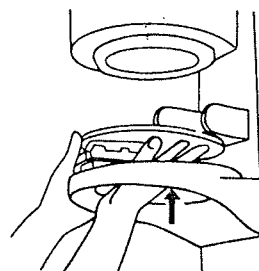

10) Dismantle the blade assembly as follows :

- Unscrew the (2) blade fastening screws and remove blade and blade holder.

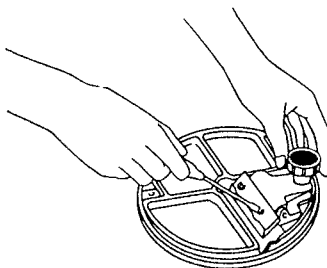

- Remove the blade adjustment knob and washer by turning the knob clockwise.

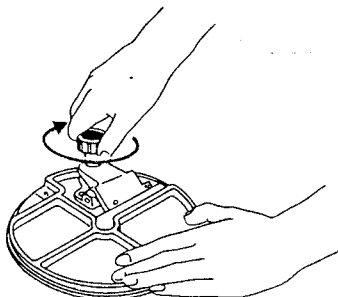

- Unscrew the (2) screws fastening blade assembly to shaving plate and remove blade assembly.

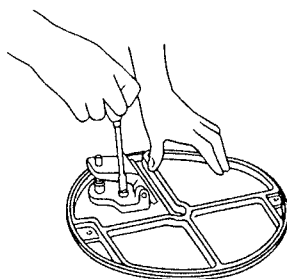

- Dismantle blade assembly-consisting of base plate, stopper ring, spring, blade fitting plate and blade fitting plate shaft.

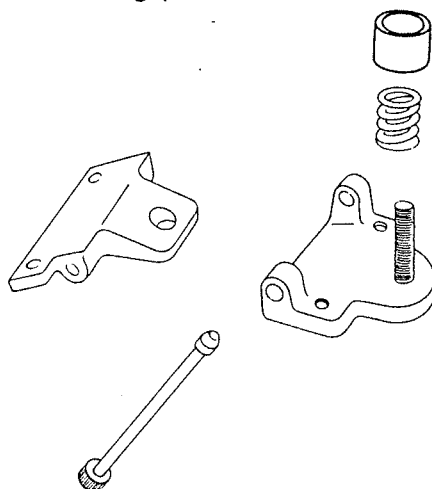

* After finishing cleaning and sterilization, lay parts at a dry place.

- Reassemble the unit in reverse order of disassembly.

Specifications

Dimensions	: $12\frac{23}{32}" \times 17\frac{25}{32}" \times 25\frac{25}{64}"$ (W×D×H)
Electrical	: 115V 1 phase 60Hz 3.9A 220W
RPM	: 250 rpm
Output	: 200 W
Shaving Capacity	: 4.4 lbs/minute
Ice Block Capacity	: $5\frac{9}{16}" \times 5\frac{9}{16}" \times 5\frac{7}{8}"$
Shaving plate diameter	: $8\frac{5}{8}"$
Weight	: 68 lbs (33kgs)

Accessories

Tray	1
Extra blade	1
Gear oil	1

Manufactured by :

CHUBU CORPORATION

Kuwana, Mie, Japan.